

햄스터 로봇 소개

광운대학교 로봇학부
박광현

하드웨어 소개

크기 · 무게 · 전원 스위치

3

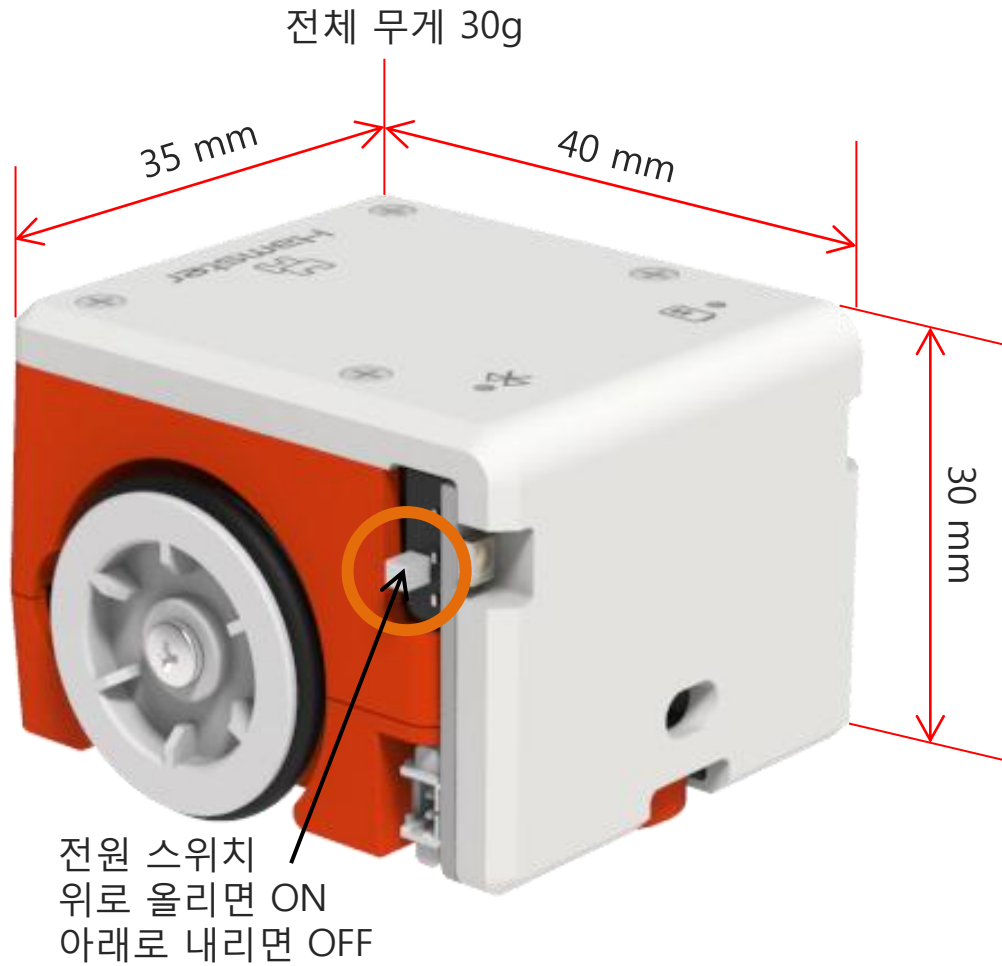

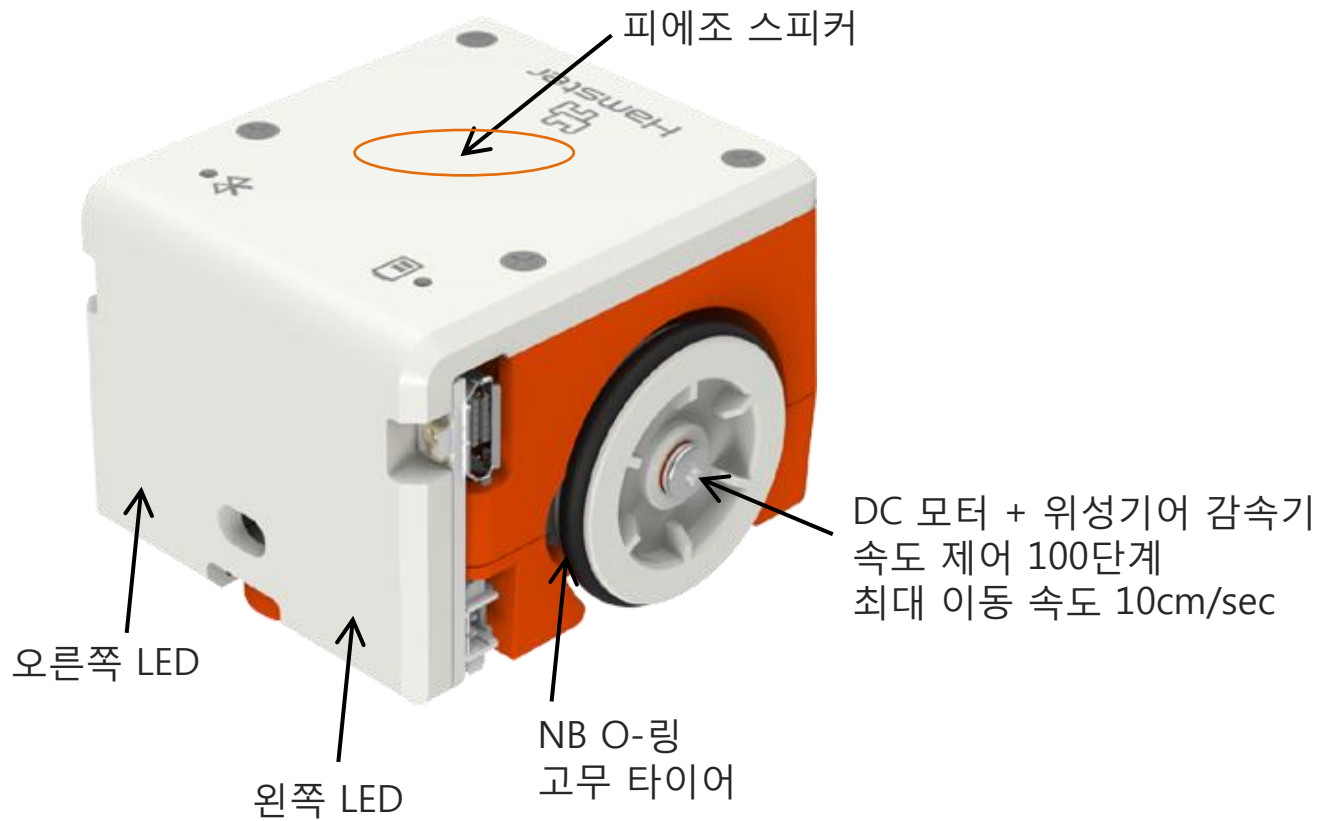

입력 장치

근접 센서 (적외선 센서)
1~30cm, 1mm 정밀도
햇빛 아래 동작 가능

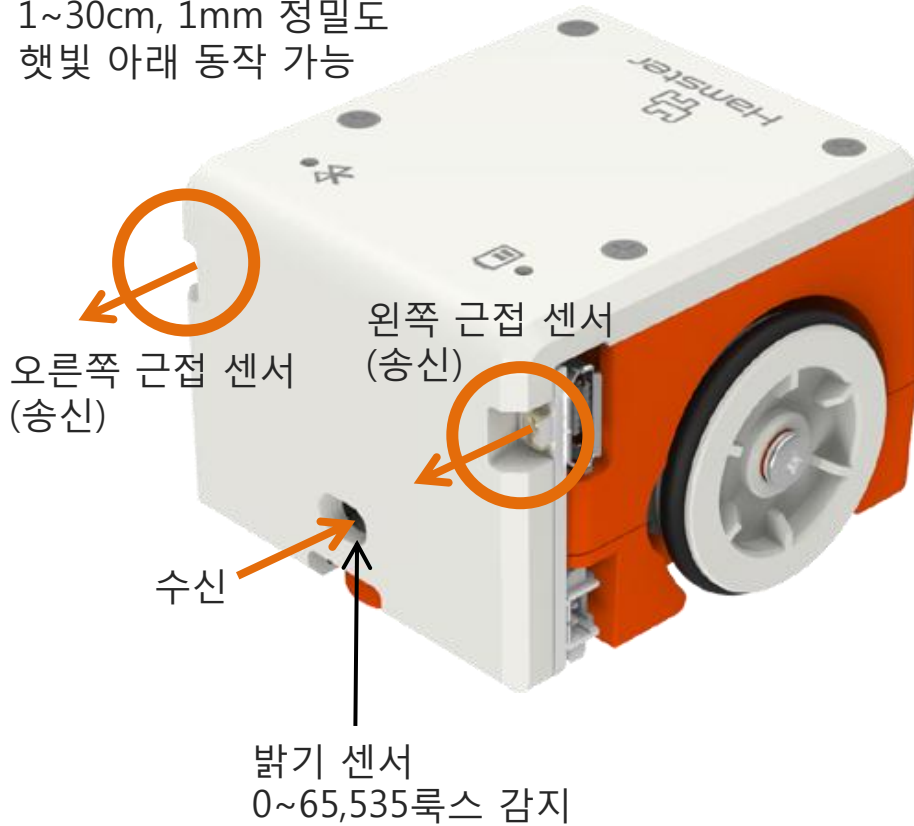

왼쪽 바닥 센서
(적외선 센서)
0~255단계 감지





내장 리튬 배터리 3.7V, 120mA
충전 약 30분
연속 동작 평균 1시간
대기 최대 12시간



보조 전원 단자
3.7V 리튬 폴리머 전지



외부 입출력 단자 (포트A, 포트B)
디지털 입력, ADC 입력
디지털 출력, 아날로그(PWM) 출력
아날로그 서보 제어 출력

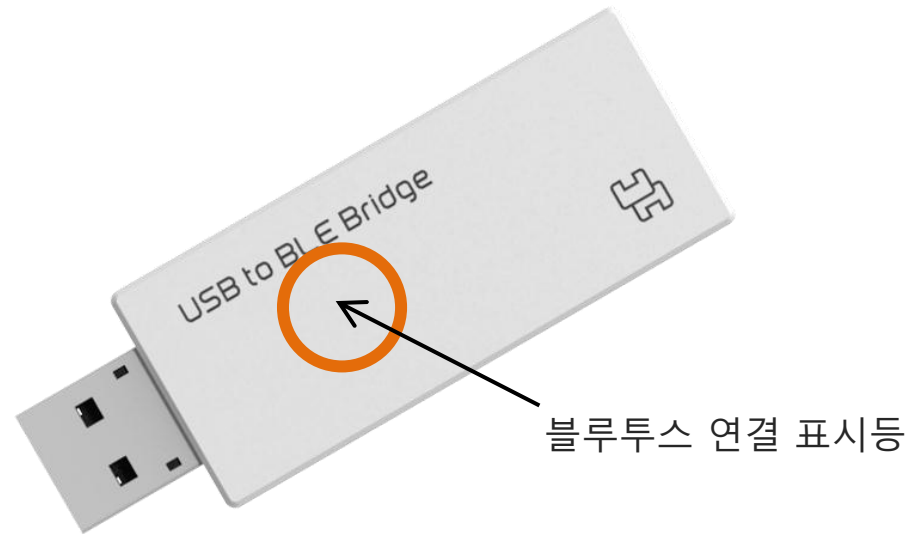

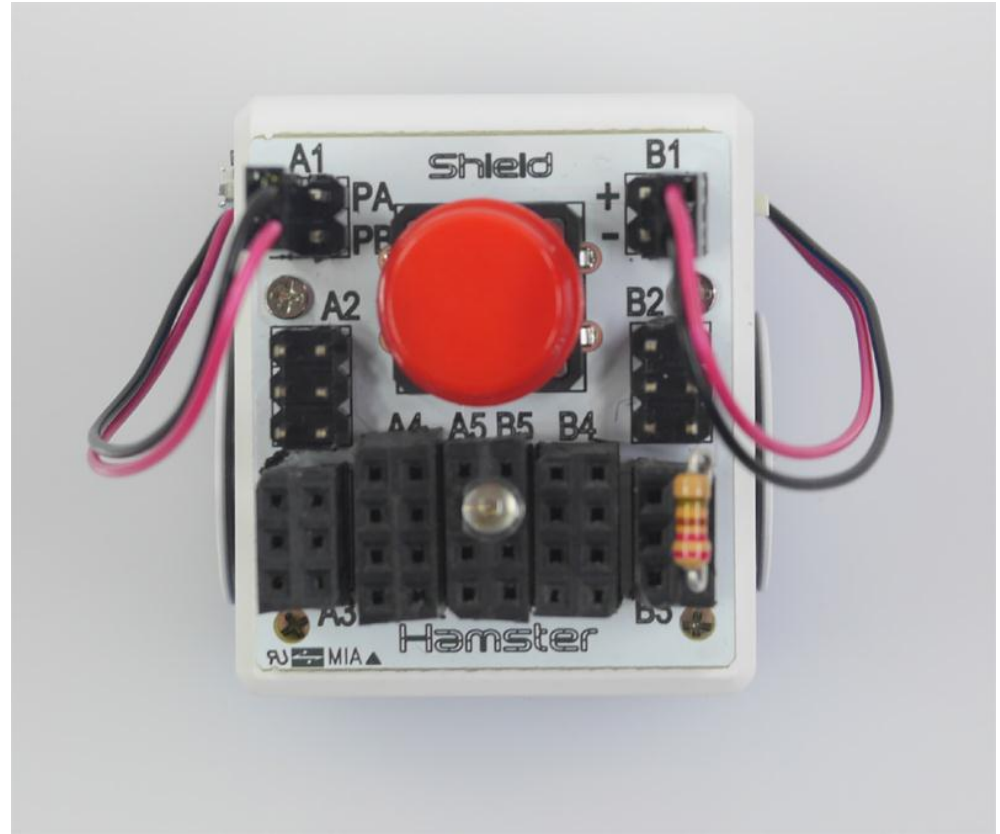

소프트웨어 소개



스크래치 설치 및 사용

https://scratch.mit.edu/scratch2download

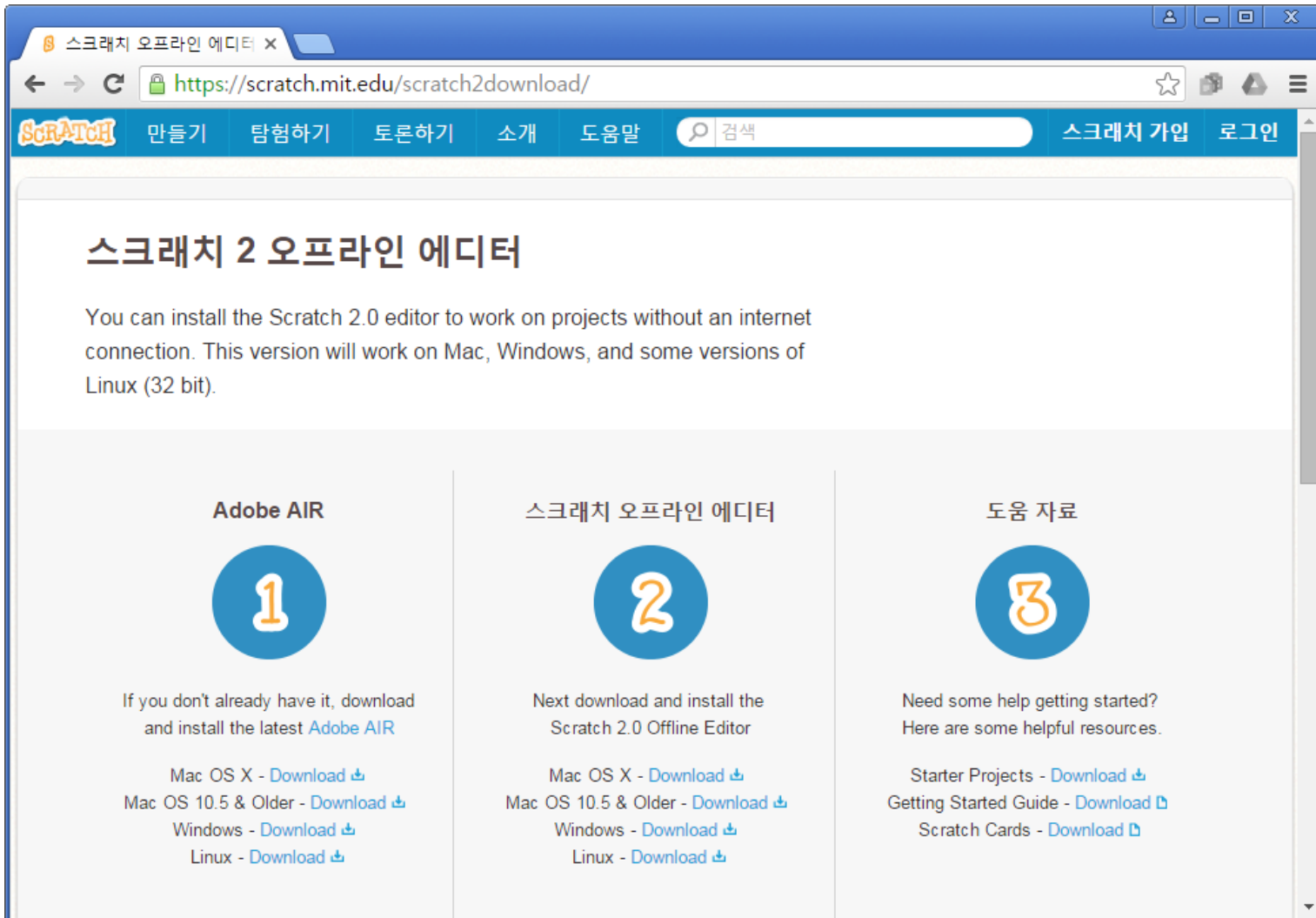

http://hamster.school

The screenshot shows a web browser window with the URL `hamster.school/ko/download/`. The page title is 'Hamster School' and the language is set to '한국어'. The main navigation menu includes 'SW 다운로드', '교육 자료', '문제 해결', '레퍼런스', and '구입하기'. The '소프트웨어 다운로드' section is highlighted in orange. On the left sidebar, there are categories for '바로가기', '그래픽 언어' (with sub-items '로봇 코딩 소프트웨어' and '로보이드 스튜디오'), '스크립트 언어' (with sub-items '프로세싱' and '파이썬 라이브러리'), '고급 언어' (with sub-items 'C 라이브러리', 'C++ 라이브러리', and '자바 라이브러리'), and '기타' (with sub-item '디바이스 드라이버'). The main content area is titled '그래픽 언어' and features a product card for '로봇 코딩 소프트웨어: 스크래치 + 엔트리 + 자바스크립트' with version 1.2 (released 2016.01.10). The card includes a list of bullet points: '로봇 코딩 SW를 설치하면 스크래치와 엔트리, 자바스크립트를 사용할 수 있습니다.', 'USB 동글의 디바이스 드라이버는 설치 파일에 포함되어 있으며, 설치 과정에서 디바이스 드라이버도 같이 설치됩니다.', and 'USB 동글을 PC에 연결하기 전에 로봇 코딩 소프트웨어를 먼저 설치해야 합니다.'. Below the list, there is a section titled '설치 파일' (highlighted with an orange box) containing three links: '윈도우 32비트 버전', '윈도우 64비트 버전', and 'OSX 64비트 버전'. At the bottom, there is a section titled '설치 및 실행 방법' with two links: '스크래치' and '엔트리'.

1. USB 동글을
PC의 USB 단자에 연결
2. 햄스터 로봇의
전원 켜기
3. 햄스터 로봇을
USB 동글 가까이
가져가기 (15cm 이내)



1. USB 동글을
PC의 USB 단자에 연결



2. 햄스터 로봇의
전원 켜기



로봇 코딩 소프트웨어 실행

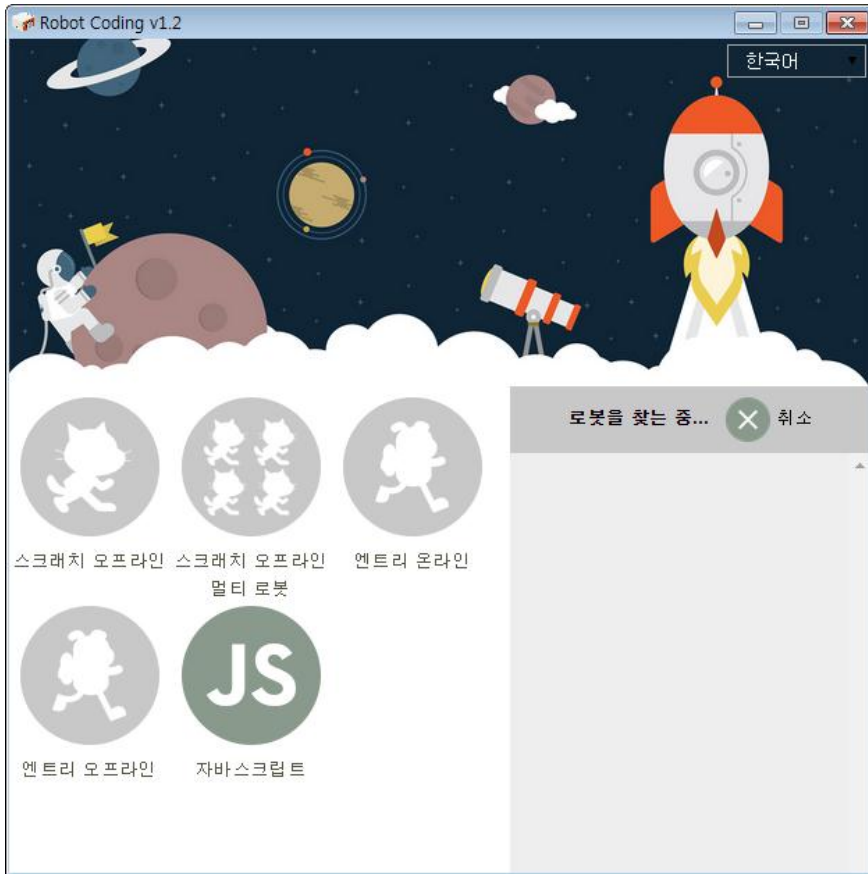

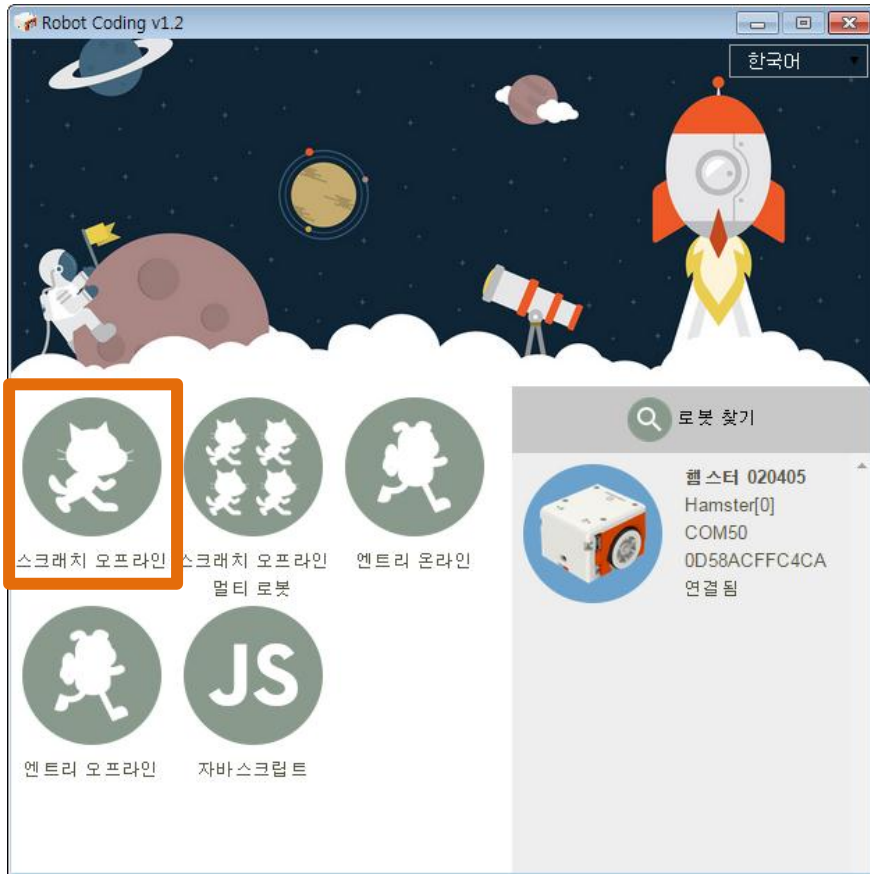

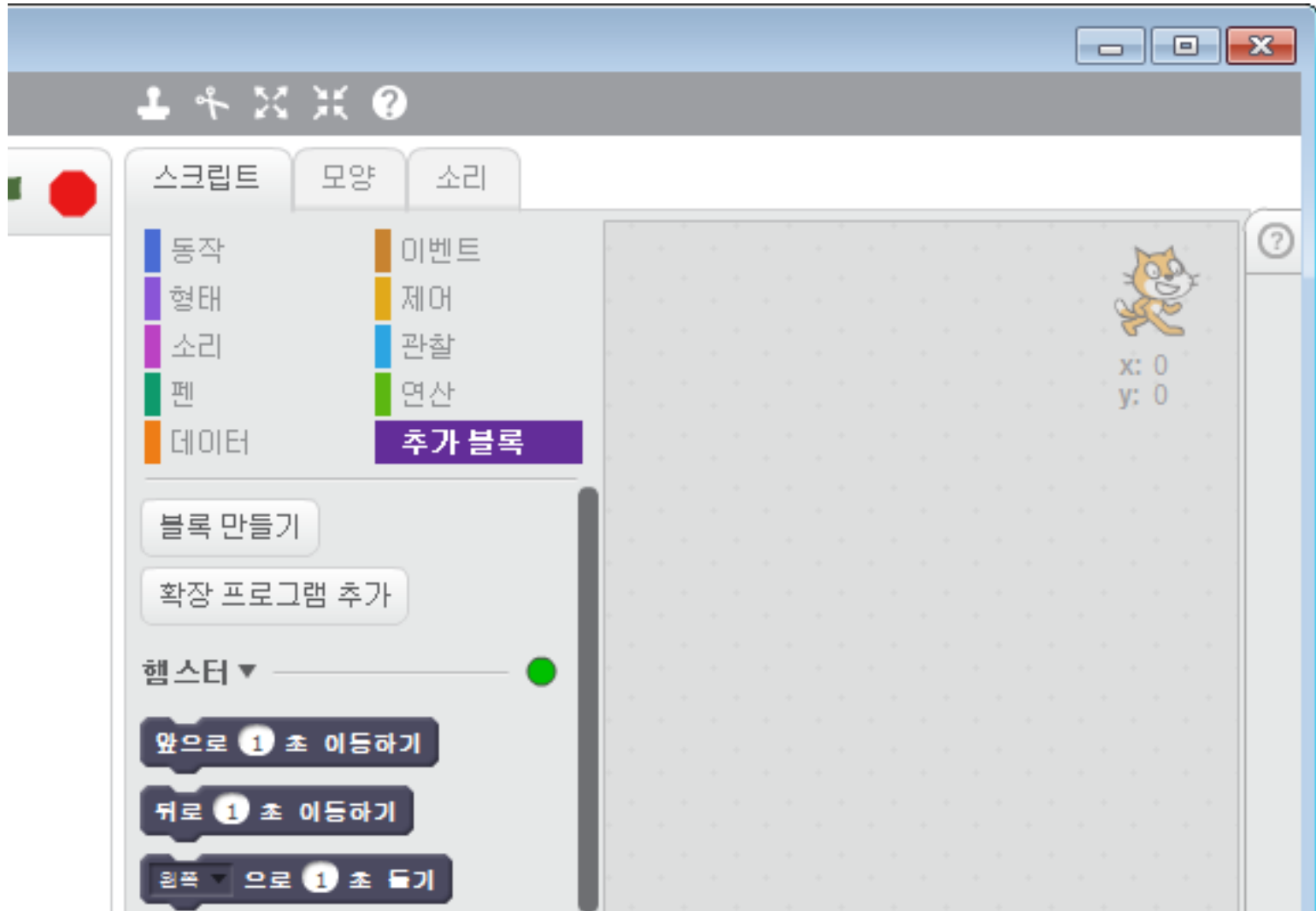

엔트리 설치 및 사용

블록 프로그램 작성

햄스터 로봇 제어

웹 브라우저 (온라인)

로봇 코딩 소프트웨어

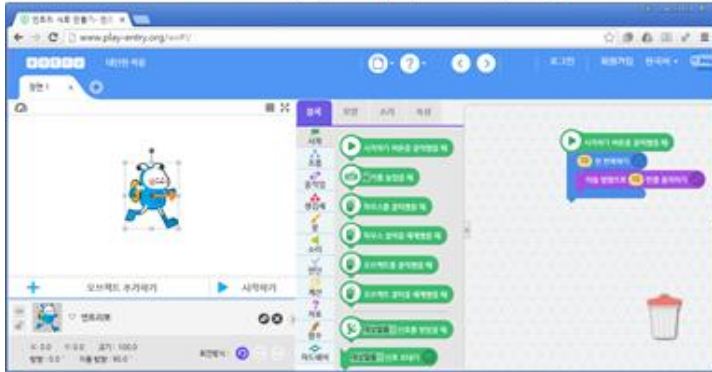

햄스터 로봇



엔트리 오프라인 에디터

엔트리 연결 프로그램



http://hamster.school

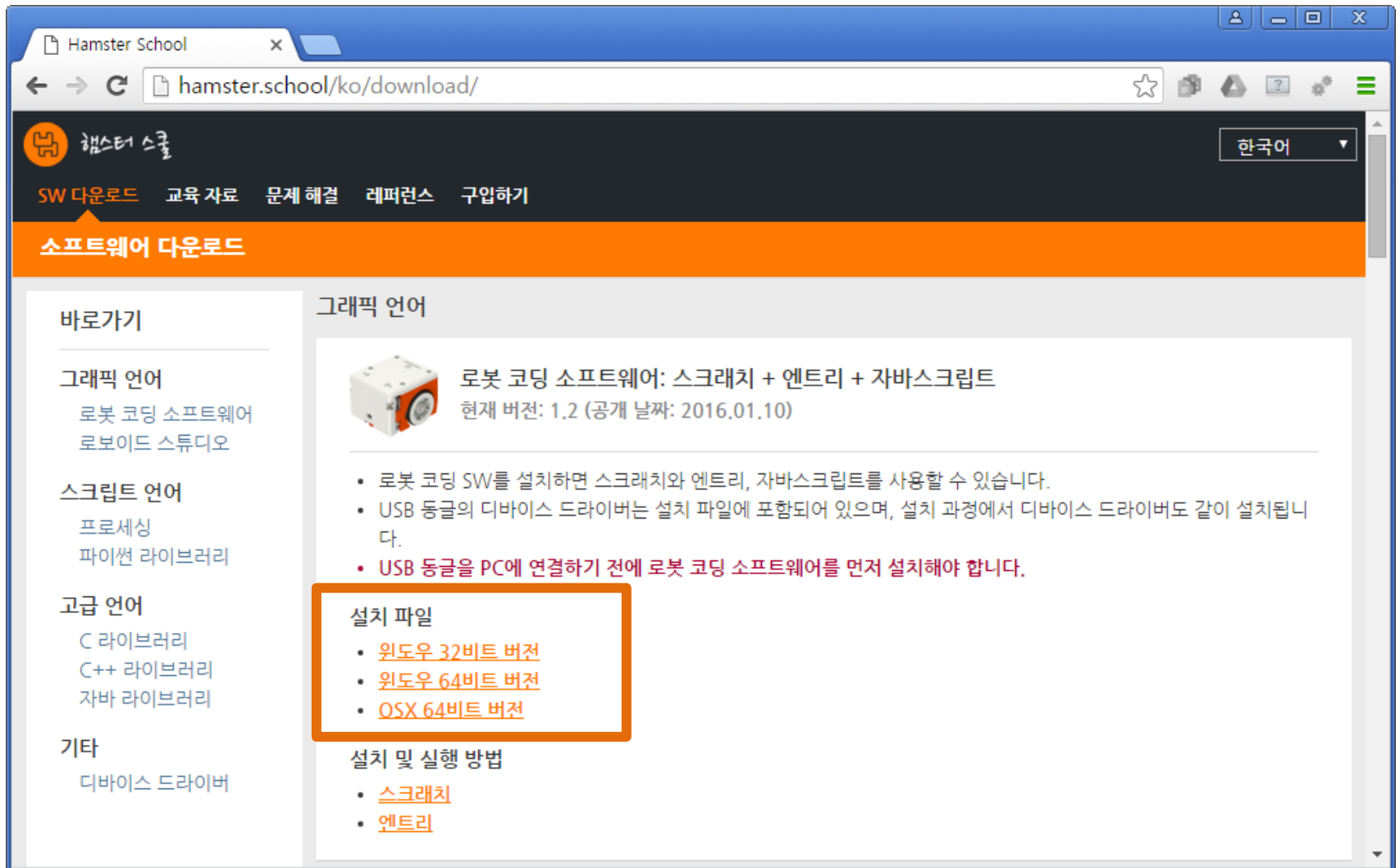

The screenshot shows a web browser window with the URL `hamster.school/ko/download/`. The page title is "Hamster School" and the language is set to "한국어". The main navigation menu includes "SW 다운로드", "교육 자료", "문제 해결", "레퍼런스", and "구입하기". The "소프트웨어 다운로드" section is highlighted in orange. On the left sidebar, there are categories: "바로가기", "그래픽 언어" (with sub-items "로봇 코딩 소프트웨어" and "로보이드 스튜디오"), "스크립트 언어" (with sub-items "프로세싱" and "파이썬 라이브러리"), "고급 언어" (with sub-items "C 라이브러리", "C++ 라이브러리", and "자바 라이브러리"), and "기타" (with sub-item "디바이스 드라이버"). The main content area is titled "그래픽 언어" and features a section for "로봇 코딩 소프트웨어: 스크래치 + 엔트리 + 자바스크립트" with the current version "1.2" and a release date of "2016.01.10". A list of instructions includes: "로봇 코딩 SW를 설치하면 스크래치와 엔트리, 자바스크립트를 사용할 수 있습니다.", "USB 동글의 디바이스 드라이버는 설치 파일에 포함되어 있으며, 설치 과정에서 디바이스 드라이버도 같이 설치됩니다.", and "USB 동글을 PC에 연결하기 전에 로봇 코딩 소프트웨어를 먼저 설치해야 합니다." Below this, a box highlights the "설치 파일" section with links for "윈도우 32비트 버전", "윈도우 64비트 버전", and "OSX 64비트 버전". At the bottom, the "설치 및 실행 방법" section lists "스크래치" and "엔트리".

http://www.play-entry.org

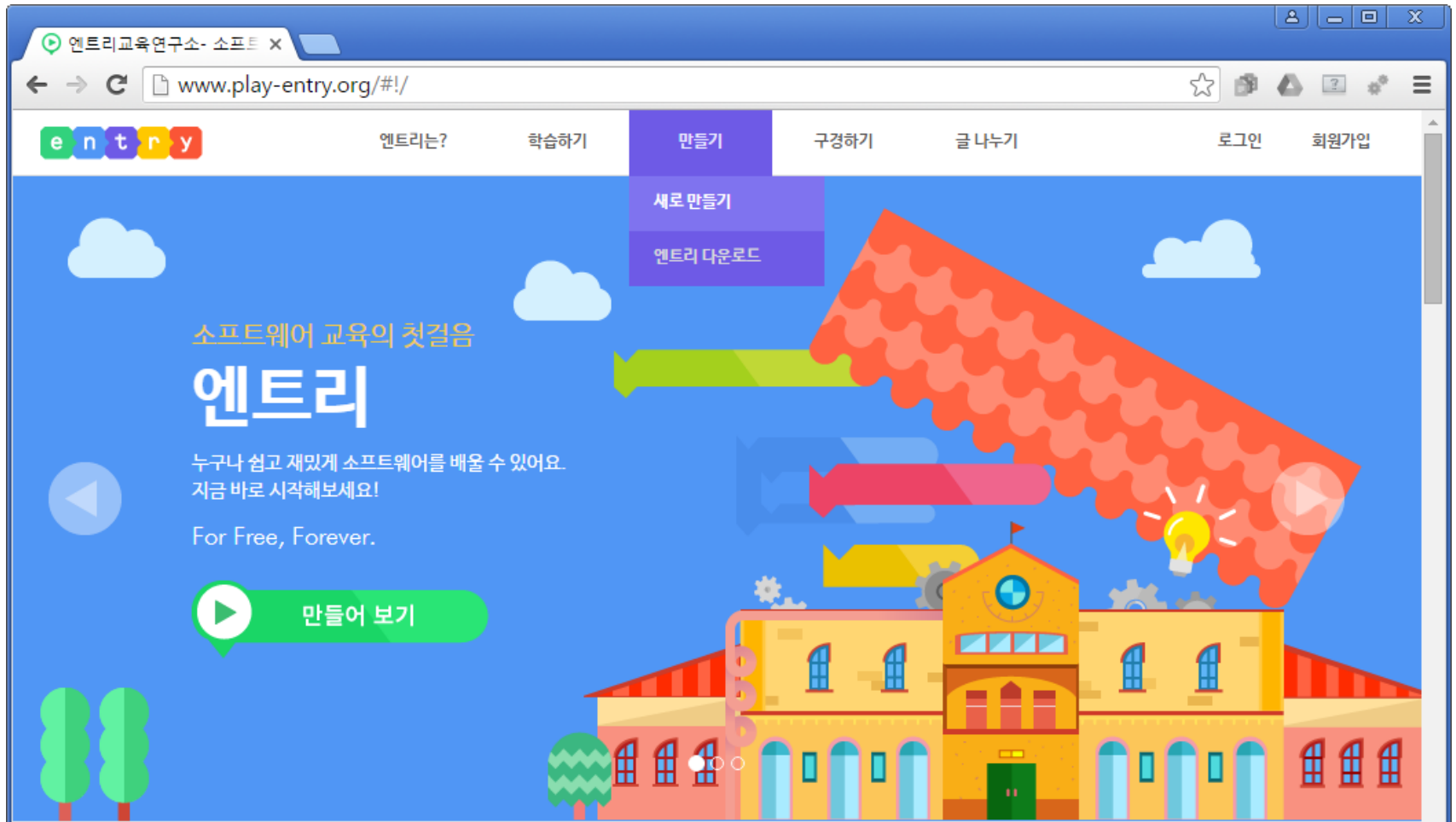

엔트리 연결 프로그램 설치

24

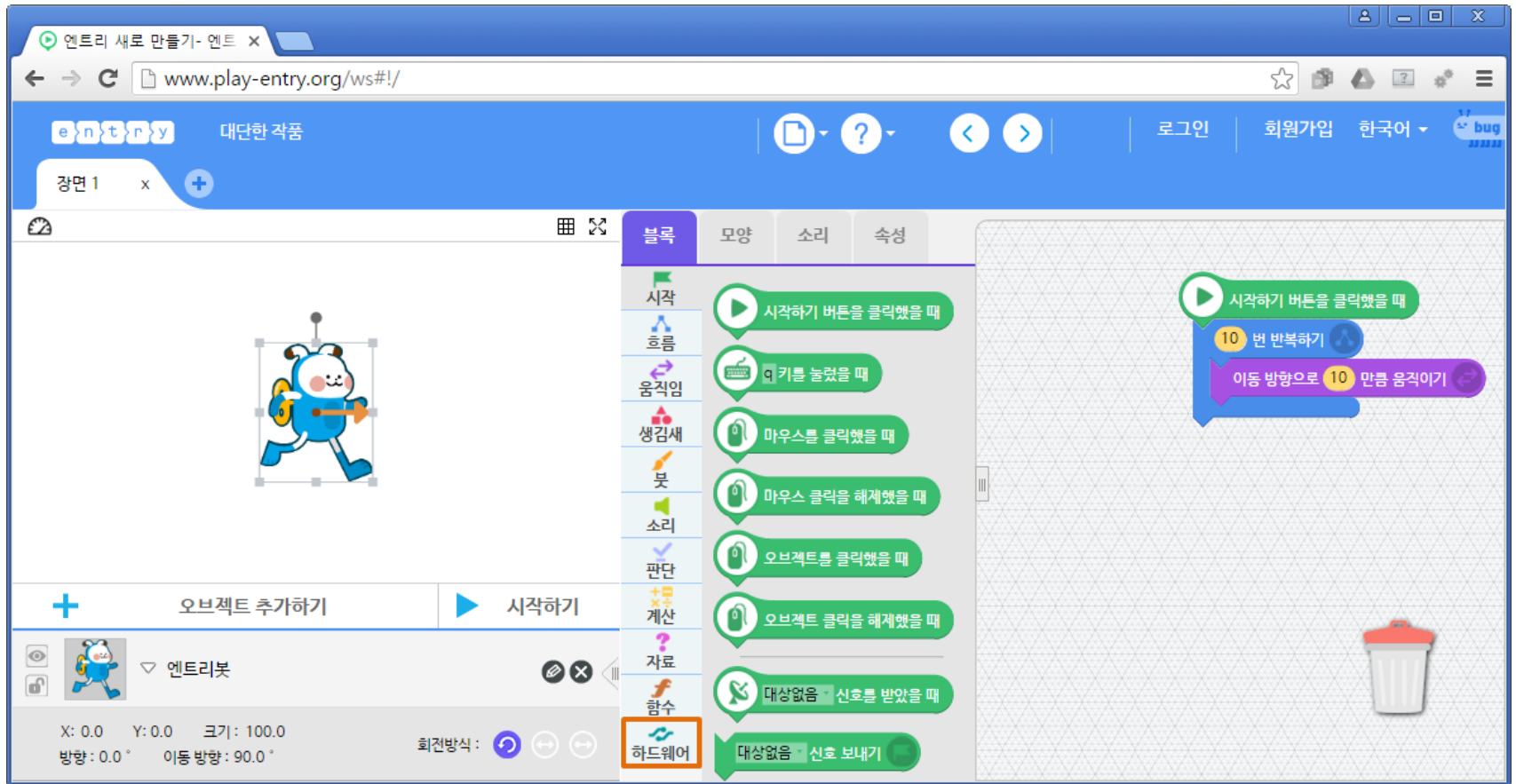

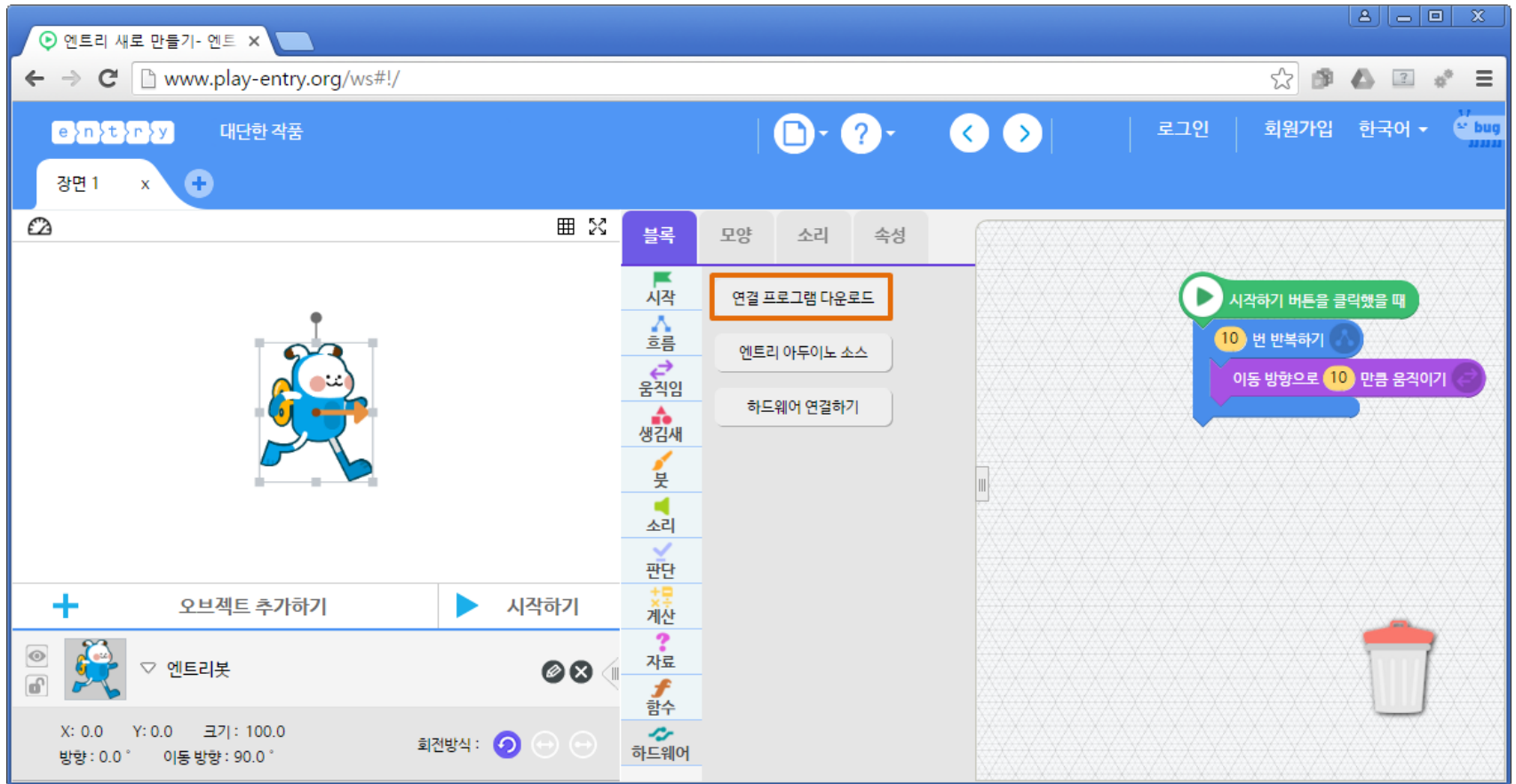

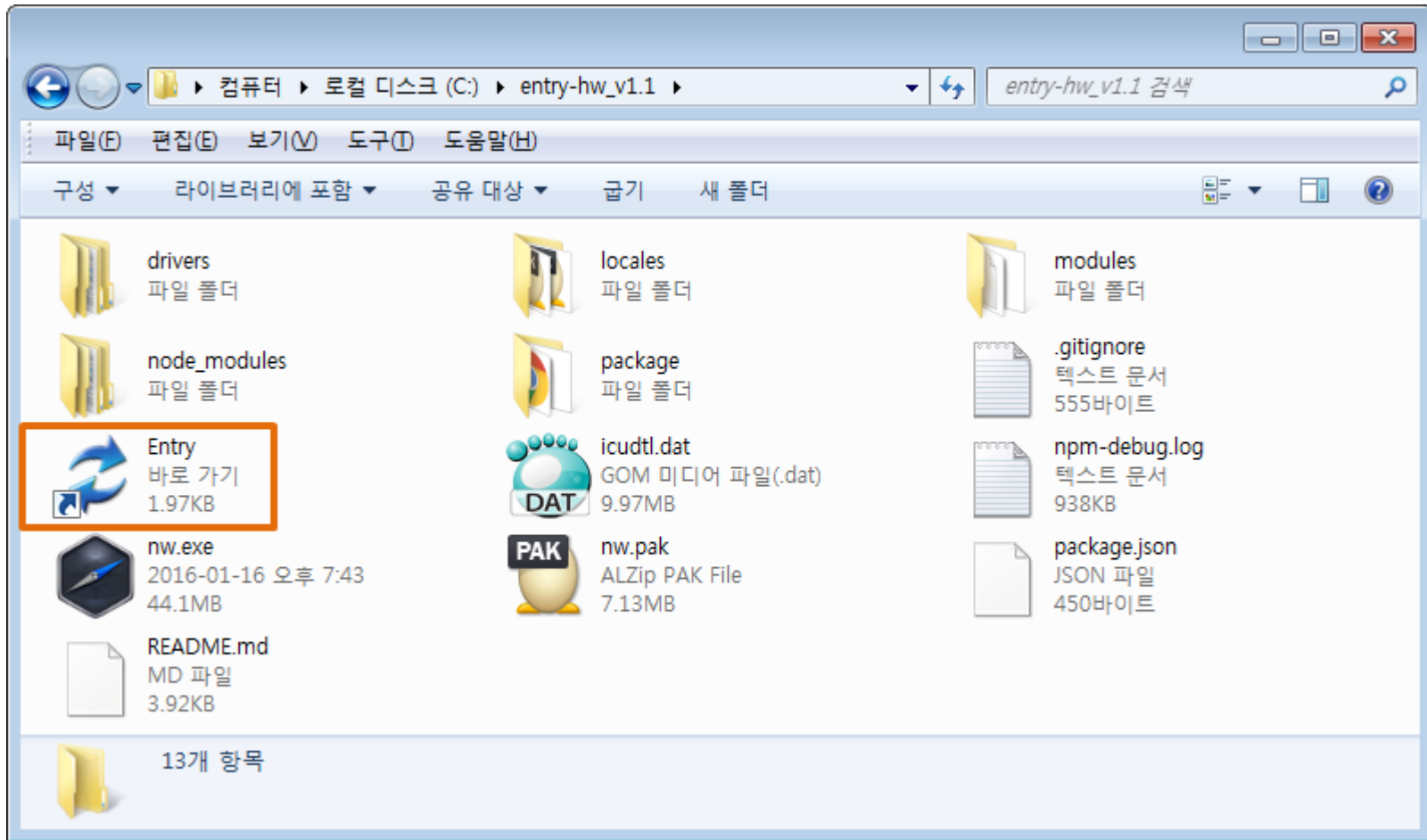







엔트리 연결 프로그램 설치

Entry Server v1.1

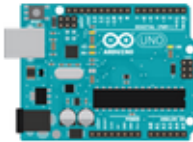
하드웨어 선택

Internet Explorer에서는 하드웨어 연결이 되지 않습니다.

[chrome 다운로드 바로가기 >](#)

 알버트 스쿨 버전	 아두이노	 비트브릭	 디오
 엔트리 센서 보드	 햄스터	 리틀비츠	 오렌지 보드

entry™



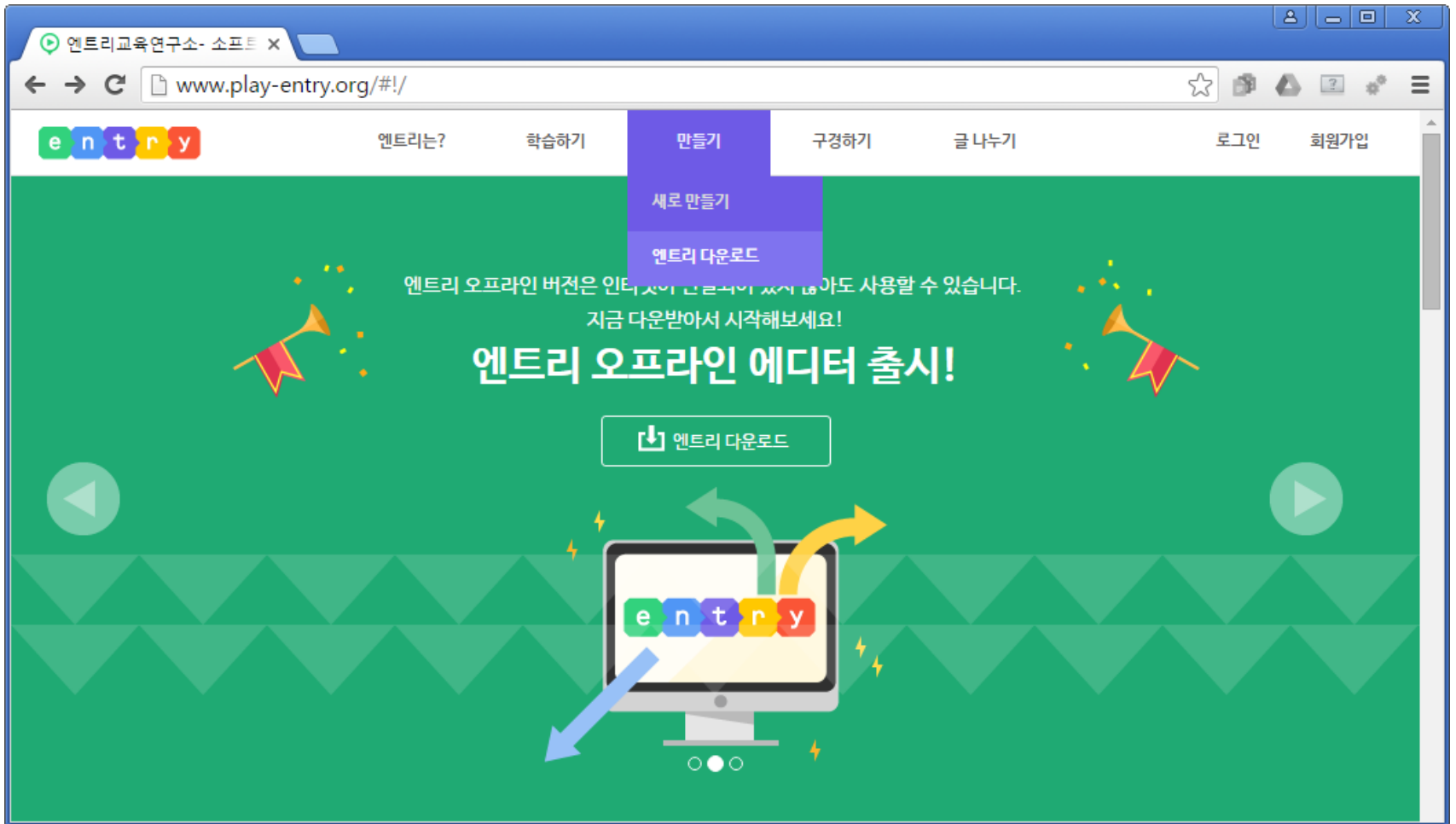

엔트리교육연구소 - 소프트 X

www.play-entry.org/#!/offlineEditor

entry 엔트리는? 학습하기 만들기 구경하기 글 나누기 로그인 회원가입

엔트리 오프라인 다운로드

엔트리 오프라인 버전은 인터넷이 연결되어 있지 않아도 사용할 수 있습니다.
지금 다운로드해서 시작해보세요!

Windows 다운로드

Mac 다운로드

버전 1.0.0 | 언어 한국어, 영어 | 크기 Windows 140 MB, Mac 180 MB | 업데이트 2015.11.30

1. USB 동글을
PC의 USB 단자에 연결
2. 햄스터 로봇의
전원 켜기
3. 햄스터 로봇을
USB 동글 가까이
가져가기 (15cm 이내)



1. USB 동글을
PC의 USB 단자에 연결



2. 햄스터 로봇의
전원 켜기



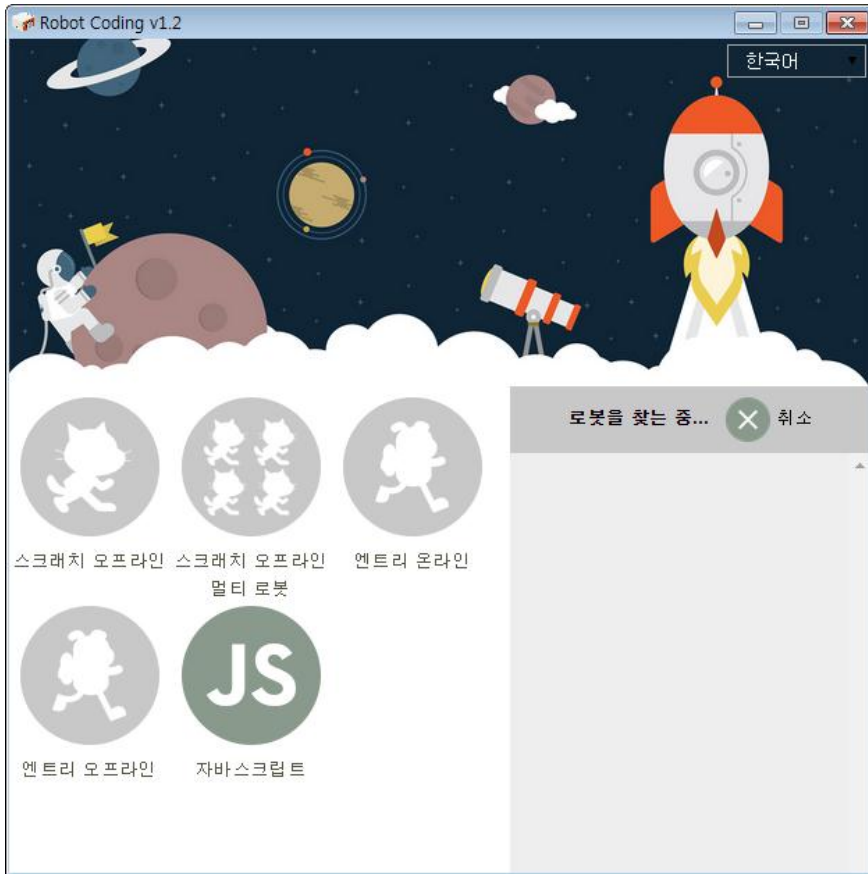







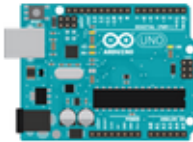

Entry Server v1.1

하드웨어 선택

Internet Explorer에서는 하드웨어 연결이 되지 않습니다.

[chrome 다운로드 바로가기 >](#)

 알버트 스쿨 버전	 아두이노	 비트브릭	 디오
 엔트리 센서 보드	 햄스터	 리틀비츠	 오렌지 보드

entry™

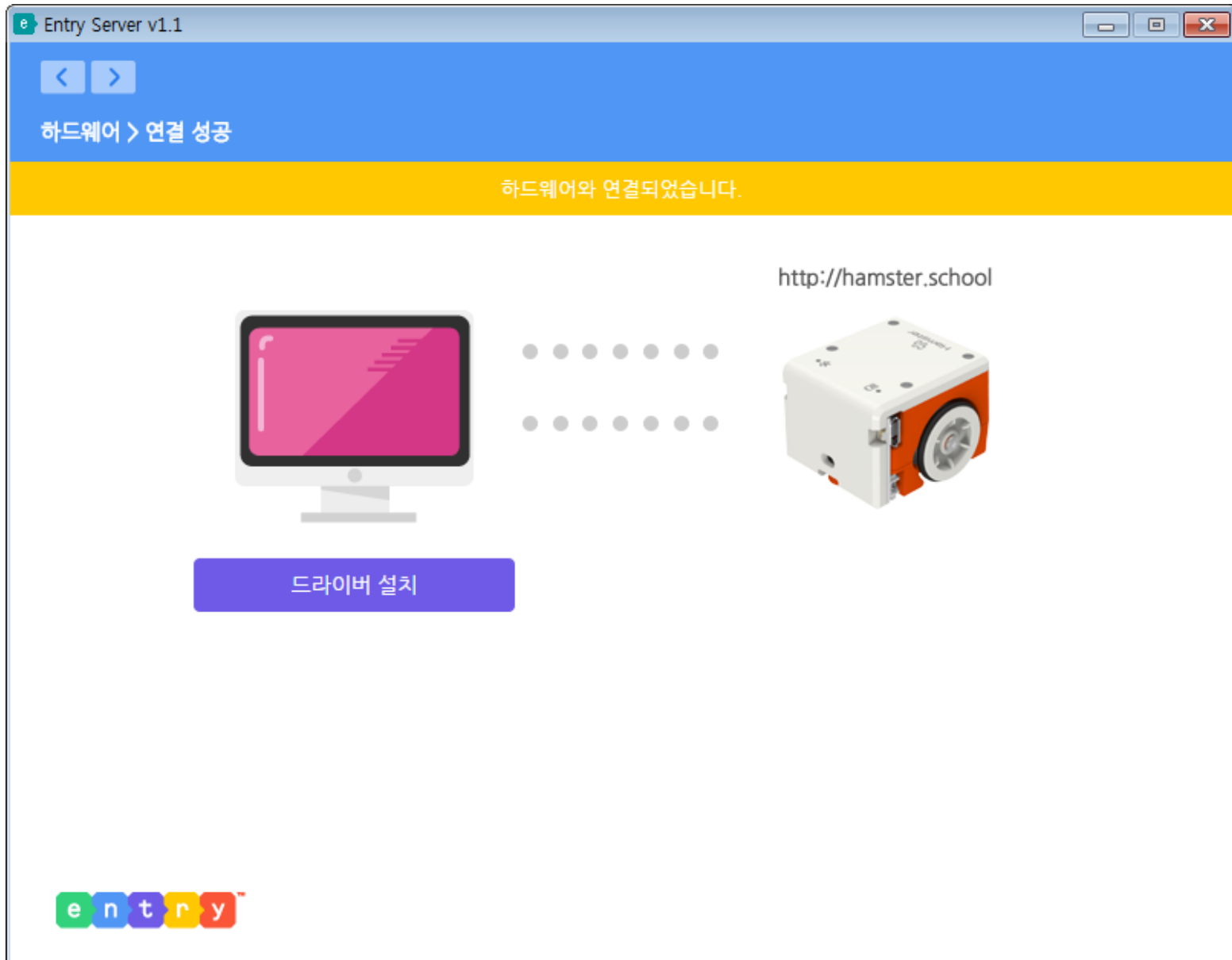

블록 프로그램 작성

햄스터 로봇 제어

웹 브라우저 (온라인)

로봇 코딩 소프트웨어

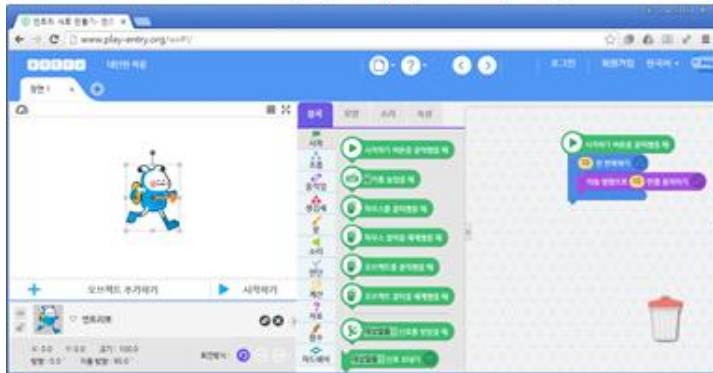

햄스터 로봇



엔트리 오프라인 에디터

엔트리 연결 프로그램



동영상

라인 트레이싱

39

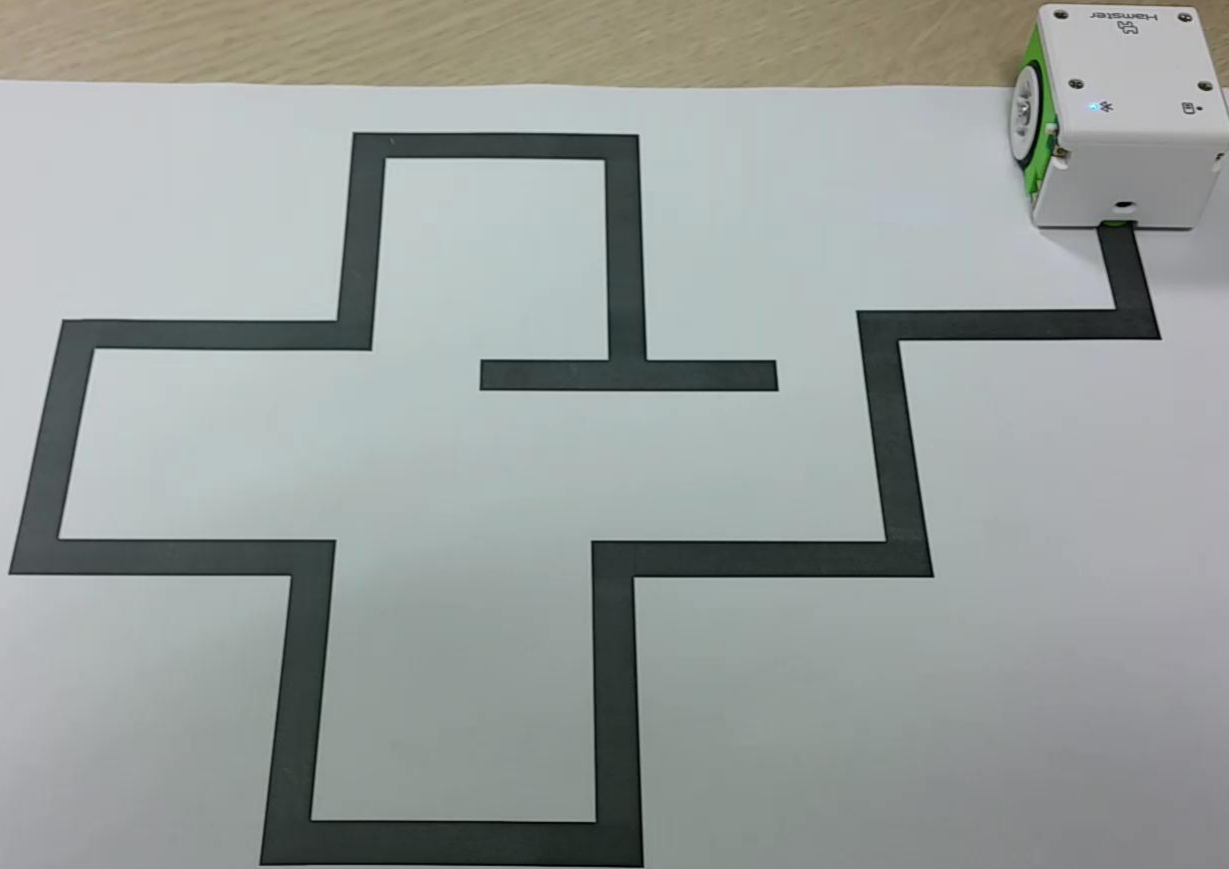

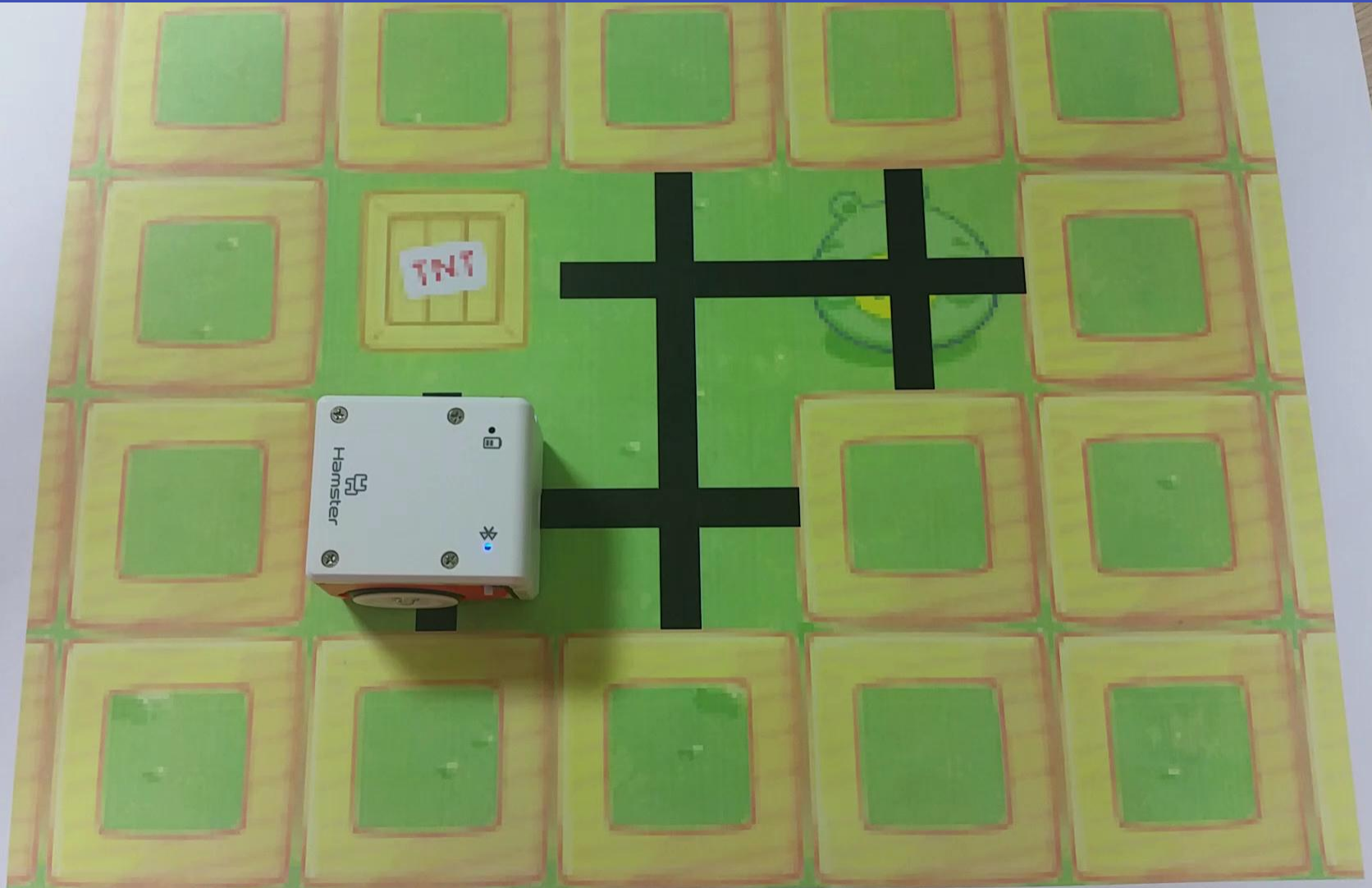

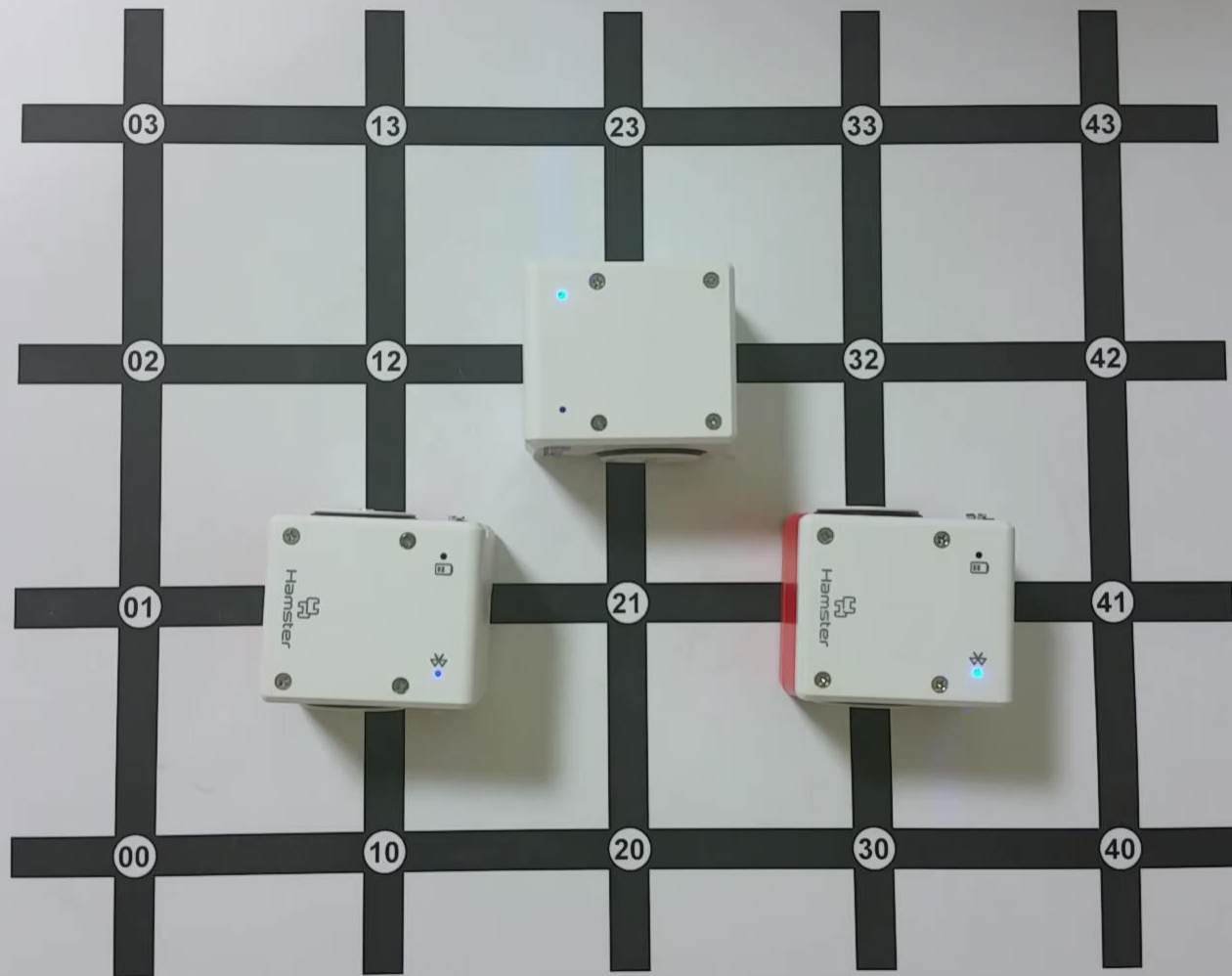

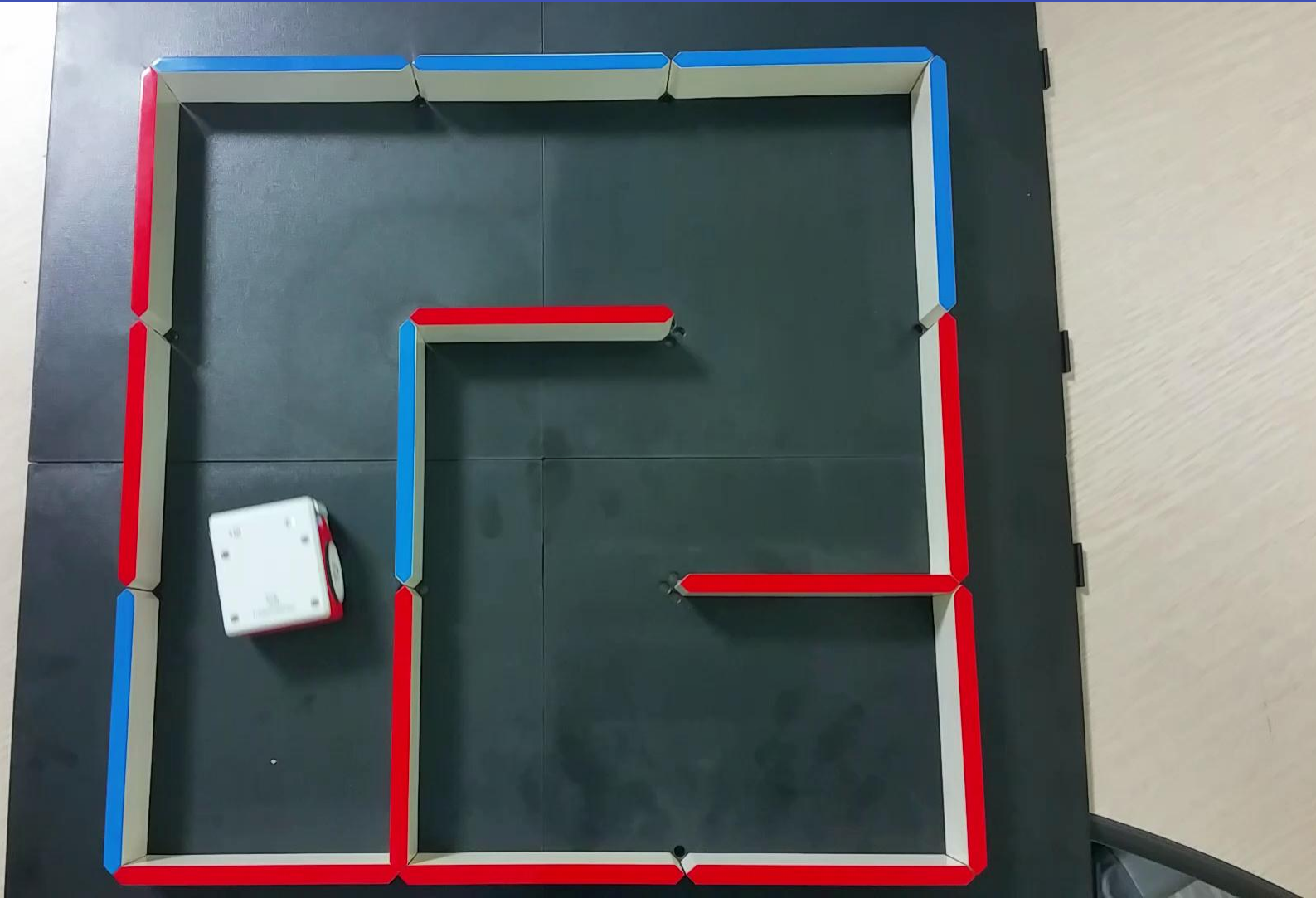

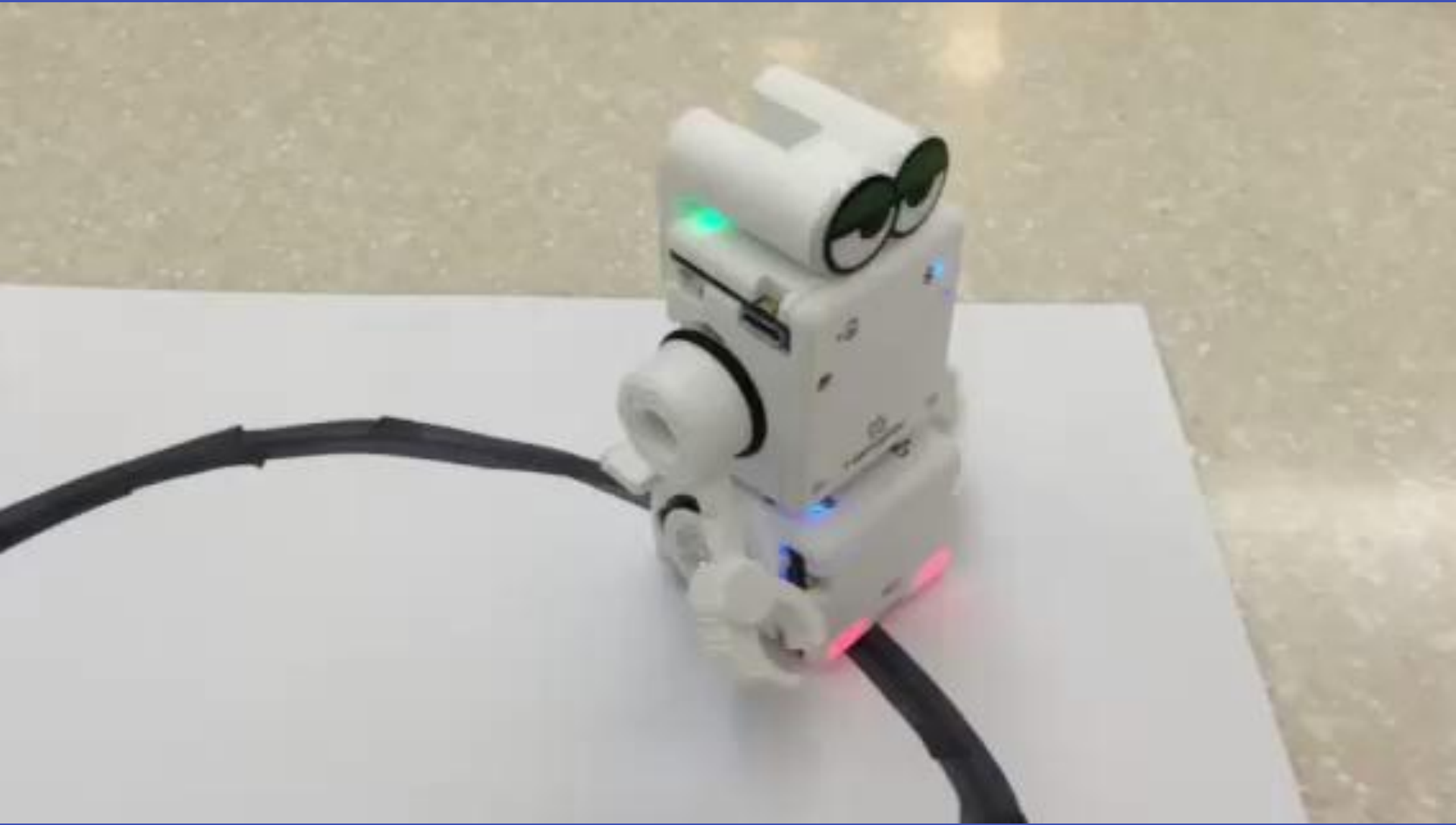



컵 잡기

45

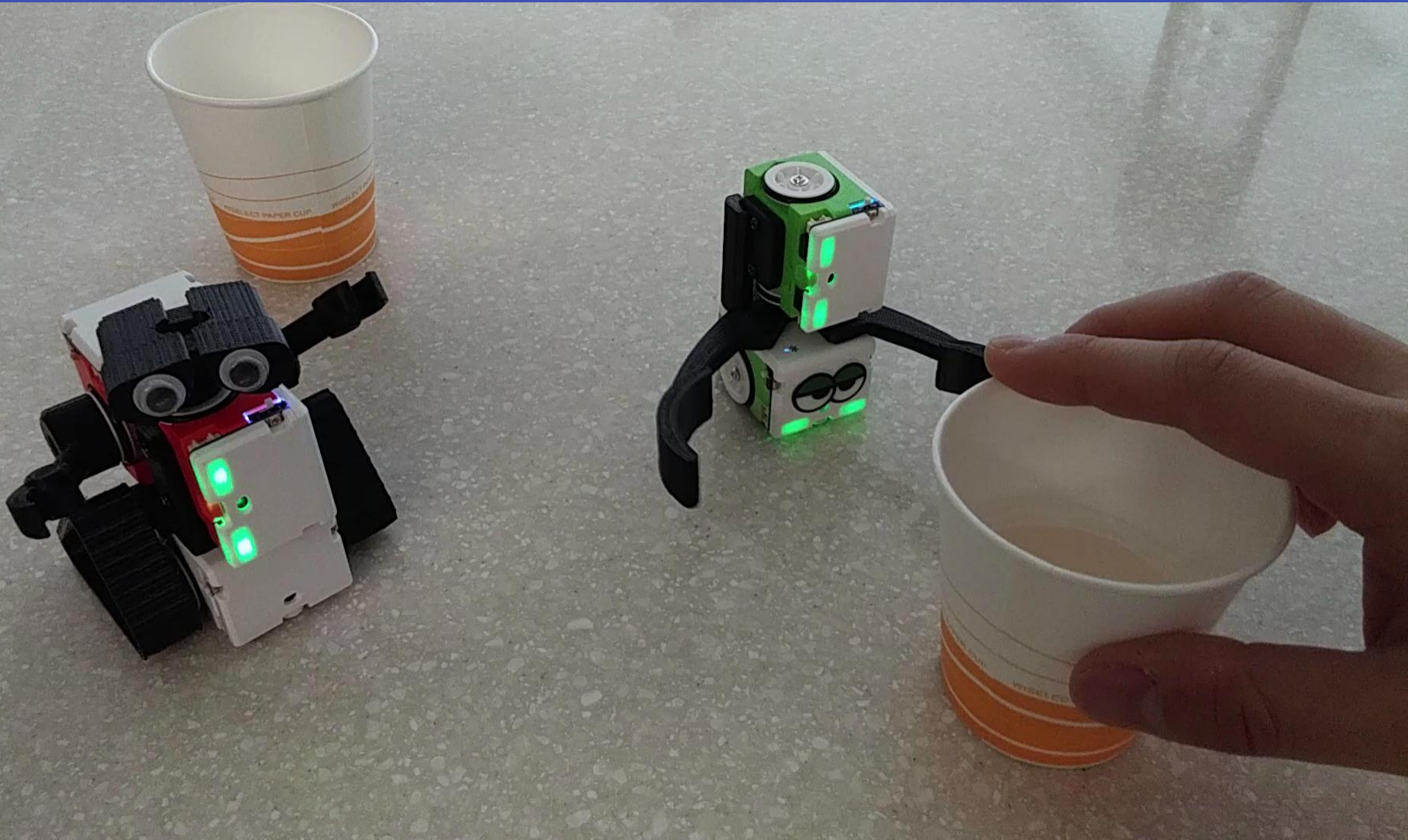



간단한 실습

앞으로 1 초 이동하기

뒤로 1 초 이동하기

왼쪽 ▾ 으로 1 초 돌기

앞으로 1 초 이동하기

뒤로 1 초 이동하기

왼쪽 ▾ 으로 1 초 돌기



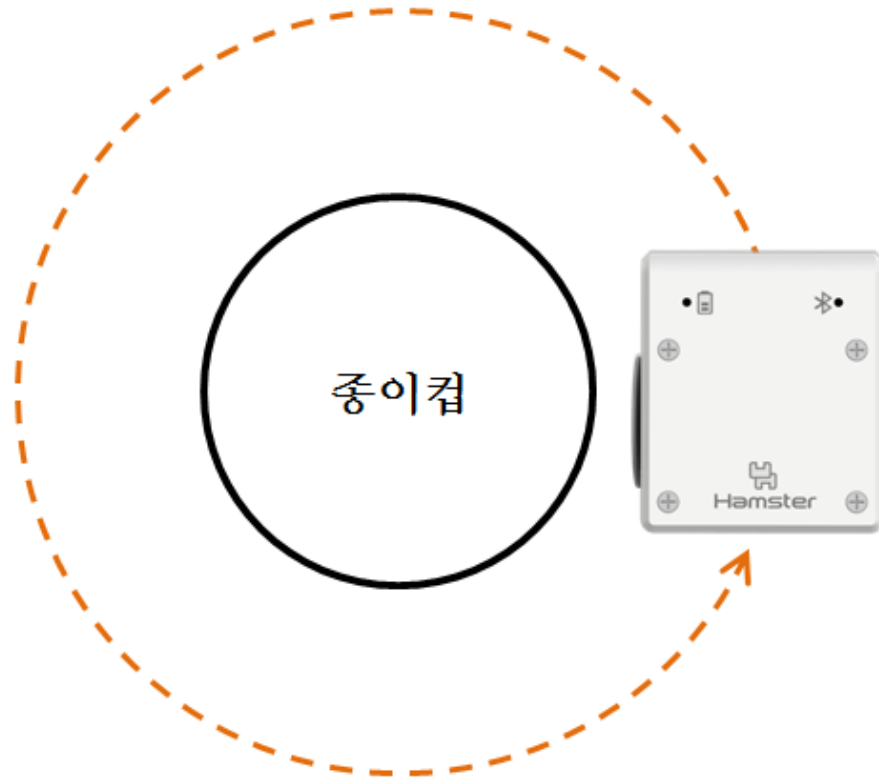

- 키보드의 키를 눌러 원격 조종하는 햄스터 조종기 만들기



수고하셨습니다.

akaii@kw.ac.kr